



FMMT4124 TRANSISTOR (NPN)

COLLECTOR

FEATURES

Power dissipation

$$P_{CM} : 0.33W (T_{amb}=25)$$

Collector current

$$I_{CM} : 0.2A$$

Collector-base voltage

$$V_{(BR)CBO} : 30V$$

Operating and storage junction temperature range

$$T_J, T_{stg} : -55 \text{ to } +150$$

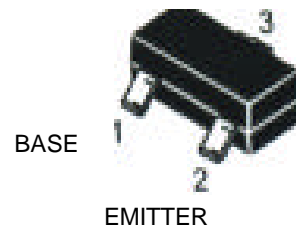

SOT—23

Marking : 2C

ELECTRICAL CHARACTERISTICS ($T_{amb}=25$ unless otherwise specified)

Parameter	Symbol	Test conditions	MIN	TYP	MAX	UNIT
Collector-base breakdown voltage	$V_{(BR)CBO}$	$I_C=10 \mu A, I_E=0$	30			V
Collector-emitter breakdown voltage	$V_{(BR)CEO}$	$I_C=1mA, I_B=0$	25			V
Emitter-base breakdown voltage	$V_{(BR)EBO}$	$I_E=10 \mu A, I_C=0$	5			V
Collector cut-off current	I_{CBO}	$V_{CB}=20V, I_E=0$			0.05	μA
Emitter cut-off current	I_{EBO}	$V_{EB}=3V, I_C=0$			0.05	μA
DC current gain	H_{FE}	$V_{CE}=1V, I_C=2mA$	120		360	
Collector-emitter saturation voltage	$V_{CE(sat)}$	$I_C=50mA, I_B=5mA$			0.3	V
Base-emitter saturation voltage	$V_{BE(sat)}$	$I_C=50mA, I_B=5mA$			0.95	V
Transition frequency	f_T	$V_{CE}=20V, I_C=10mA$ $f=100MHz$	300			MHz



Typical Characteristics

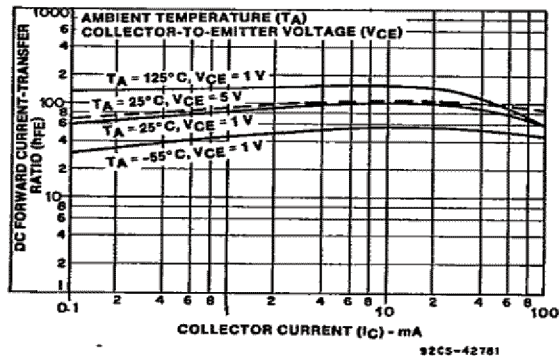

Fig. 1—Typical dc forward current transfer ratio characteristics for 2N4123.

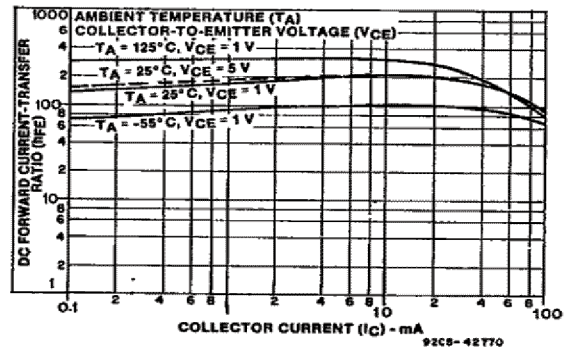

Fig. 2—Typical dc forward current transfer ratio characteristics for 2N4124.

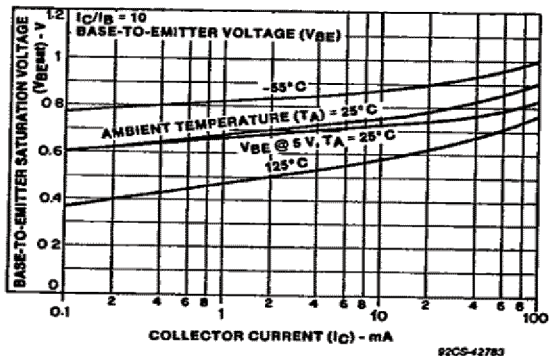

Fig. 3—Typical base-to-emitter saturation voltage characteristics for 2N4123 and 2N4124.

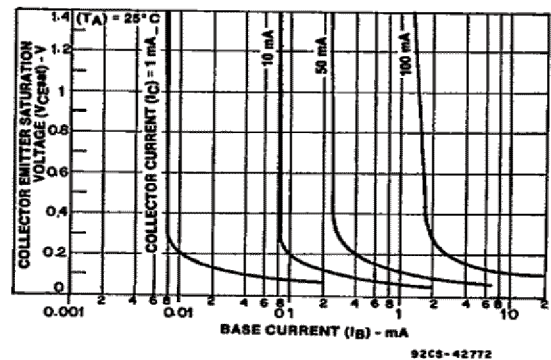

Fig. 4—Typical collector-to-emitter saturation voltage characteristics for 2N4124 and 2N4123.

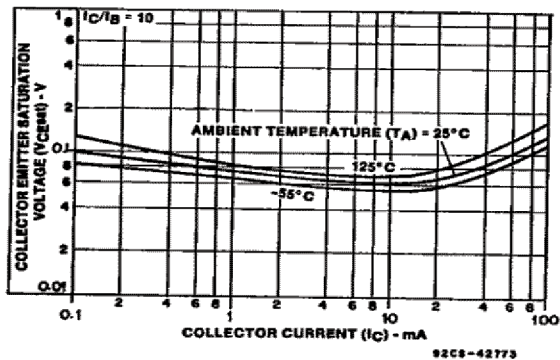

Fig. 5—Typical collector-to-emitter saturation voltage characteristics for 2N4123.

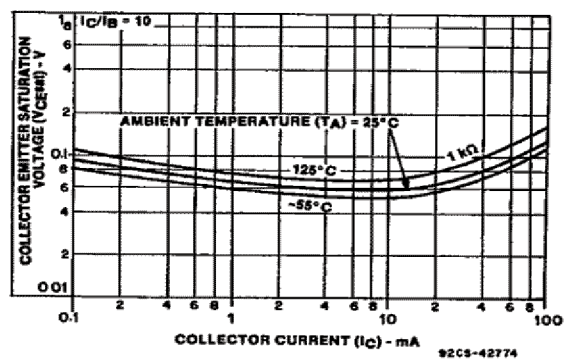

Fig. 6—Typical collector-to-emitter saturation voltage characteristics for 2N4124.

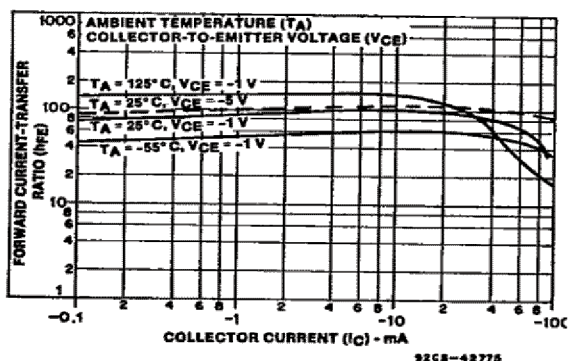

Fig. 7—Typical dc forward-current transfer ratio characteristics for 2N4125.

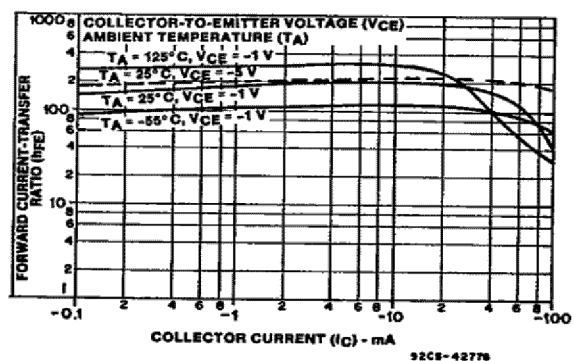

Fig. 8—Typical dc forward-current transfer ratio characteristics for 2N4126.



Typical Characteristics

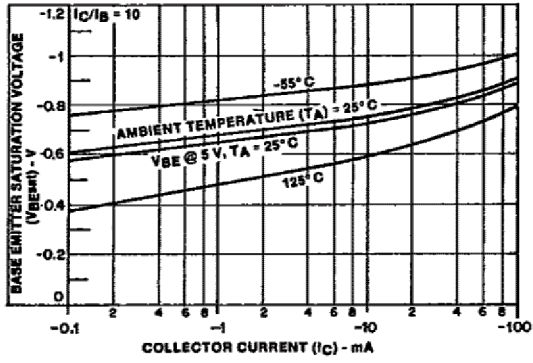

Fig. 9—Typical base-to-emitter saturation voltage characteristics for 2N4125 and 2N4126.

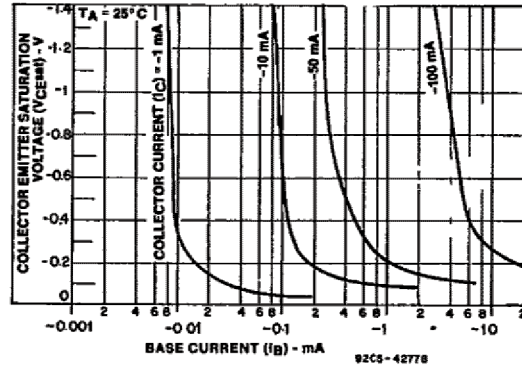

Fig. 10—Typical collector-to-emitter saturation voltage characteristics for 2N4125 and 2N4126.

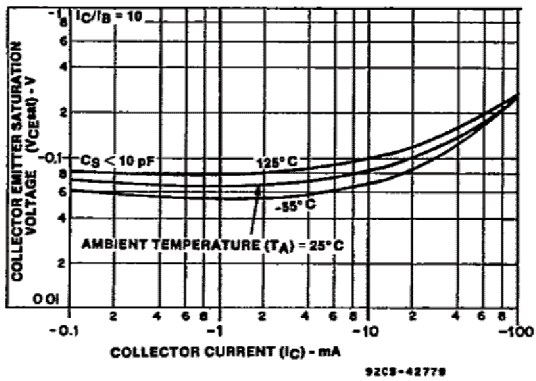

Fig. 11—Typical collector-to-emitter saturation voltage characteristics for 2N4125.

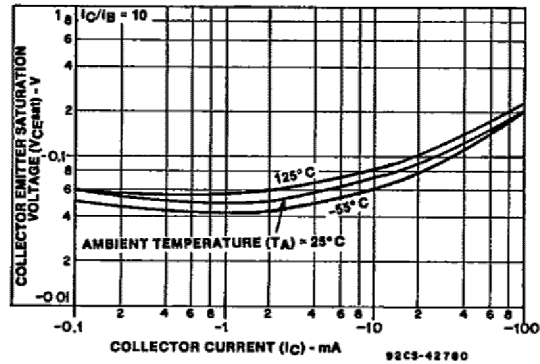

Fig. 12—Typical collector-to-emitter saturation voltage characteristics for 2N4126.



PACKAGE OUTLINE

Plastic surface mounted package; 3 leads

SOT-23

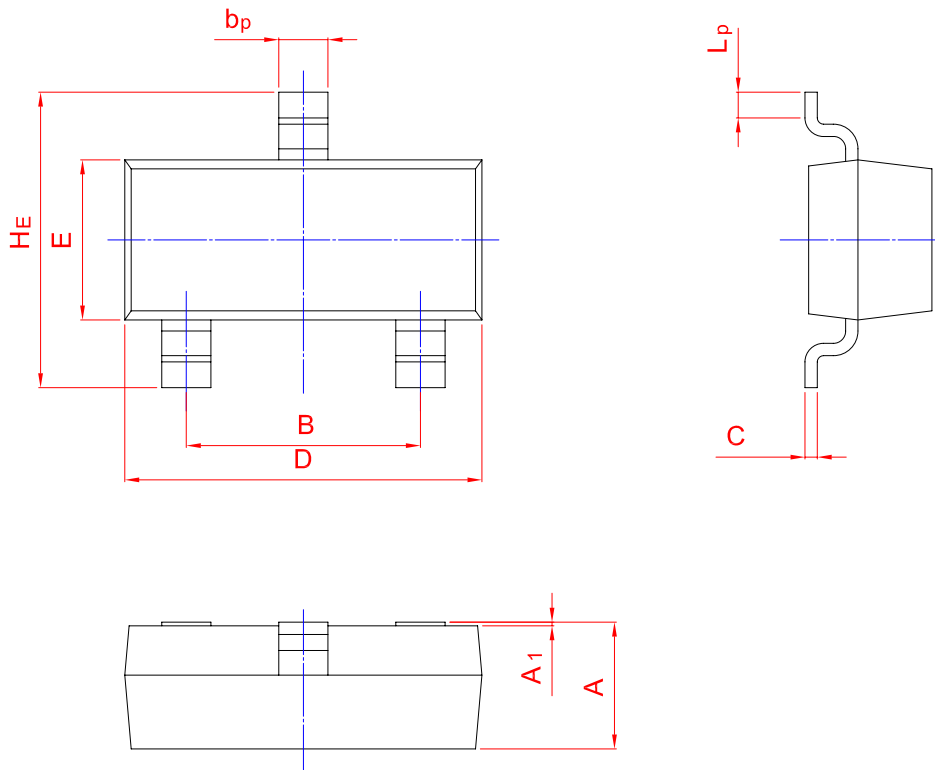
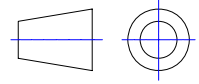

UNIT	A	B	bp	C	D	E	HE	A1	Lp
mm	1.40	2.04	0.50	0.19	3.10	1.65	3.00	0.100	0.50
	0.95	1.78	0.35	0.08	2.70	1.20	2.20	0.013	0.20